

Varenummer: 3901049045300
 Beskrivelse: Snekkegear med fri indgangsaksel
 VF 49V-45-HS

Mål

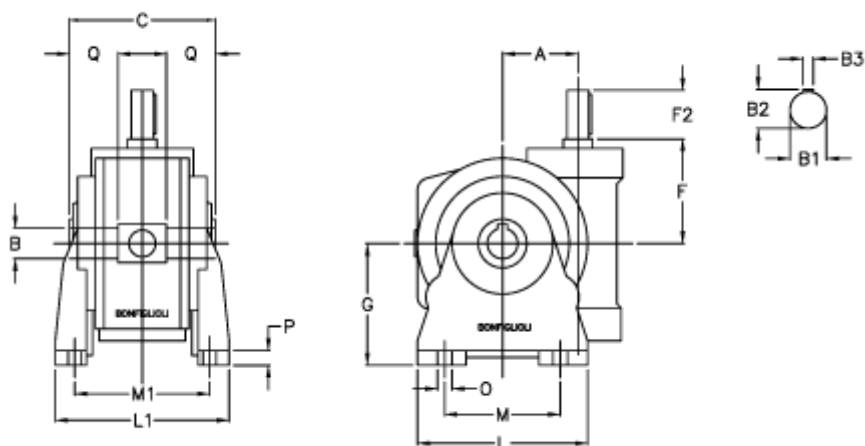

a	= 49.5	F2 = 40	Q = 22.5
B	= 25	g = 82	
B1	= 16	L = 110	
B2	= 18.0	L1 = 124	
B3	= 5	m = 63	
Betegnelse	= VF 49V-xx-HS	M1 = 98.5	
C	= 82	O = 8.5	
F	= 65.0	P = 12	